



BASIC RECOMMENDATIONS FOR FABRICATING WALKER ZANGER'S SECOLO PORCELAIN SLABS

CNC Bridge Saw Cutting Parameters:

- Make certain the porcelain slab is completely supported on the flat, level, stable, and thoroughly cleaned bridge saw cutting table.
- Use a Segmented Blade - Diameter 400 mm @ 1600 RPM @ 36" /min.
We recommend an ADI MTJ64002 - Suitable for straight and 45-degree cuts.
- Adjust the water feed directly to where the blade contacts the slab.
- Before the fabrication starts, it is important to trim 3/4" from the slab's four edges to remove any possible stress tension that may be within the slab. (*Figure 1 on next page*)
- Reduce feed rate to 18"/min for the first and last 7" for starting and finishing the cut over the full length of the slab being fabricated. (*Figure 2 on next page*)
- For 45-degree edge cuts reduce feed rate to 24" /min.
- Drill sink corners with a 3/8" core bit at 4500 RPM and depth 3/4" /min.
- Cut a secondary center sink cut 3" inside the finish cut & remove that center piece first, followed by removing the four 3" strips just inside the new sink edge. (*Figure 3 on next page*)
- Keep at least 2" of distance between the perimeter of the cut-out and the edge of the countertop.
- Use Tenax Enhancer Ager to soften the white vertical porcelain edge for under mount sink applications.
- For Statuary, Calacata Gold, and Calacata Classic slabs bond mitered edge detail with Tenax Powewrbond in the color Paper White. (Interior & Exterior Applications - Two week lead time)
- Some applications may require a supporting backer board material to be adhered to the backs of the slabs. WEDI-BOARD and Schluter-KERDI-BOARD are suitable backer materials. Exterior grade plywood may be considered for slabs that won't be exposed to moisture.
- In bonding porcelain slabs to the substrate structure be certain you have a 100% bond and there are no air pockets or voids in the setting adhesive that could allow breakage.
- If you have questions, please call: 818.280.8292



Figure 1. Trim Edges before Fabrication.

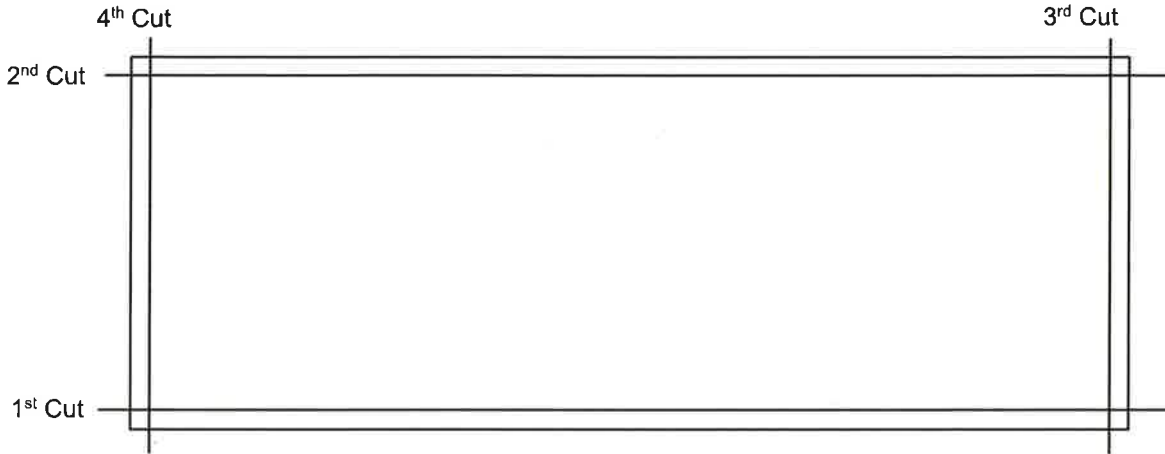
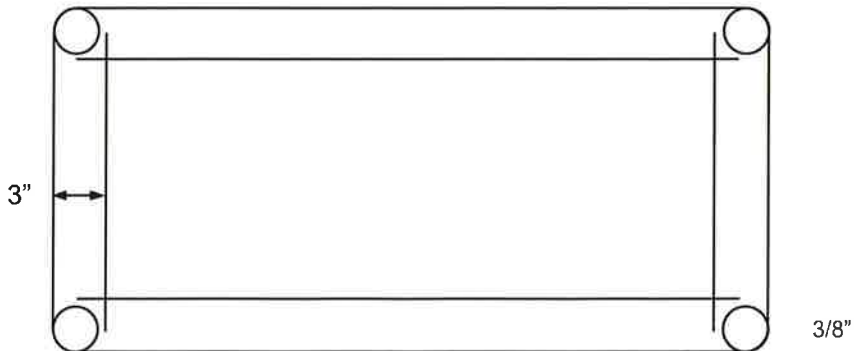

Figure 2. Reduce Feed Rate.

- It is suggested to reduce the cutting speed at about 50% at the beginning and at the end of the cut for about 7".



Figure 3. Diagram for Sink Cuts





SINK INSTALLATIONS

UNDER MOUNT SINK

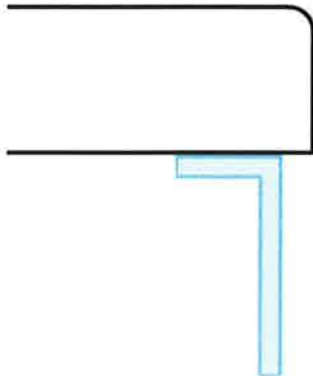

It is recommended to round the edge to make the slab stronger where it is more exposed to knocks.

FLUSH MOUNT SINK

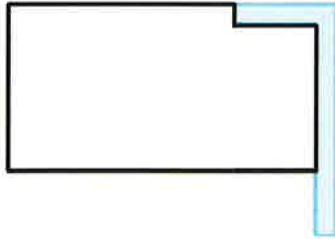

It is recommended to not reduce the thickness of the slab more than 30% of the thickness of the slab. Use 1/16" silicone joint around the perimeter to ensure waterproofing.

TOP MOUNT SINK



There is no particular recommendation because the edge is completely wrapped by the sink frame.

It is recommended to place supporting bars under the sink to hold the total weight.

EDGE SOLUTIONS

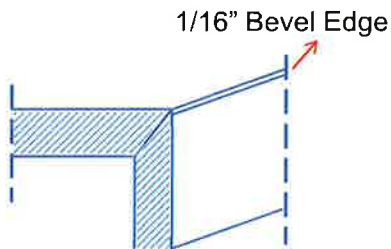

MITER EDGE

1. Miter the edges of both pieces
2. Clean each edge
3. Use epoxy to fix together the two pieces
4. The epoxy has to match the same color of the slab
5. Remove all excess epoxy

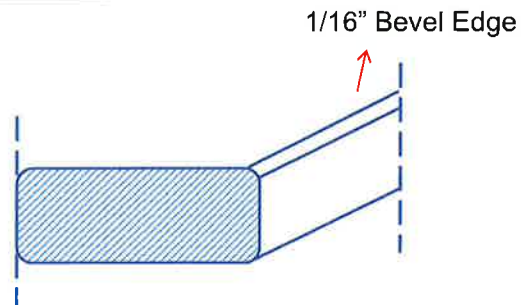

ROUND BEVEL

1. It is useful to improve the resistance of the edge of the slab against strong impacts
2. Use sandpaper recommended for porcelain
3. Start with the fine brushes and move to the thick filament brushes



Fabricating Using a Waterjet Machine

- The water level in the waterjet tank should be at the same level of the work table surface to improve the finish of the bottom of the slabs once fabricated.
- The pressure and the speed have to be adjusted according to the thickness of the slabs. For 12mm slabs the feed rate is 18"/min at 4,500 bar.

Sink and Slab Cuts with the Use of a Waterjet Machine

- For every rectangle shaped cut-out, it is suggested to keep at least 3/16" radius at each corner of the rectangle shape cut-out.
- Keep at least 2" of distance between the perimeter of the cut-out and the edge of the countertop.
- It is suggested to cut starting from outer side of the slab and in case of cut-outs, to do the entry hold outside the slab surface that will be used.





ADI Industrial Diamond Applications:

The following CNC and Portable Fabrication Saw Blades and Drill Bits are recommended to fabricate Walker Zanger's Secolo Porcelain Slabs.



SAW BLADE

Segmented Diamond Blades for ULTRA COMPACT SURFACES With Soft Bond for Low Power Machines (Less Than 20HP) With Reinforced Body for Cutting 45° On UCS Materials, LKT Materials and Glass

ADI Code	Description	RPM	FEED [mm/min]
MT J64002	Φ400 Bore Φ60	1.600	500-1.500



Blind Drills for ULTRA COMPACT SURFACES

Countersink but not through

ADI Code	Description	RPM	FEED [mm/min]
MT82006	D.6x10 A=1/2" Gas	7.000-10.000	15-30
MT82007	D.7x10 A=1/2" Gas	7.000-10.000	15-30



Under Cut Anchor System Bit for ULTRA COMPACT SURFACES

Under bevel. See edge solutions.

ADI Code	Description	RPM	FEED [mm/min]
MT83101	D.7 - 45° A=1/2" Gas	7.000-10.000	15-30
MT83012	D.10 - 45° A=1/2" Gas	7.000-10.000	15-30



Core Drills for ULTRA COMPACT SURFACES (Thin Wall 1mm)

<i>ADI Code</i>	<i>Description</i>	<i>Working Length</i>	<i>RPM</i>	<i>FEED [mm/min]</i>
MT81118	D.18 LT=75 A=1/2"	16	4.000-5.000	15-30
MT81120	D.20 LT=75 A=1/2"	16	4.000-5.000	15-30



Core Drills for ULTRA COMPACT SURFACES (Segment Thickness 2mm)

<i>ADI Code</i>	<i>Description</i>	<i>RPM</i>	<i>FEED [mm/min]</i>
MT81215	D.15 LU=55 A=1/2"	5.000-6.000	15-30
MT81218	D.18 LU=55 A=1/2"	5.000-6.000	15-30



Segmented Finger Bit for UCS

<i>ADI Code</i>	<i>Description</i>	<i>RPM</i>	<i>FEED [mm/min]</i>
MT74030	22x35 A=1/2" GAS Z6	4.500-4.800	250-300



Filotop Finger Bit for ULTRA COMPACT SURFACES Pos.2

See Sink Installations

<i>ADI Code</i>	<i>Description</i>	<i>RPM</i>	<i>FEED [mm/min]</i>	<i>Stock Removal [mm]</i>
MT75022	Φ16x15 A=1/2" GAS	5.500-6.000	1.000-1.200	0.5 Max



PCD Router for Filo top

90° cuts

<i>ADI Code</i>	<i>Dimension [mm]</i>	<i>RPM</i>	<i>FEED [mm/min]</i>	<i>Stock Removal [mm]</i>
PB35031	PCD D.12 With Water	7.000-8.000	150-250	0-3 Max



Diamond Blade for UCS Materials (Dry Cutting) For Portable Machines

<i>ADI Code</i>	<i>Description</i>
MT67013	Φ115 Bore Φ22.2
MT67014	Φ125 Bore Φ22.2



Vanity Blade for UCS Materials (Dry Beveling and Small Cutting) For Portable Machines

<i>ADI Code</i>	<i>Description</i>	<i>Grit</i>
MT67012	D.125x25+25 F=M14	#50 [Pos.1]
MT67011	D.125x25+25 F=M14	#50 [Pos.1]



Vacuum brazed Core Drills for Gres Ceramic Materials Dry Cutting

<i>ADI Code</i>	<i>Diameter</i>	<i>Connection</i>	<i>Recommended RPM</i>
MT85001	10	M14	Max 11.000
MT85002	12	M14	Max 11.000
MT85003	15	M14	Max 11.000
MT85004	20	M14	Max 11.000
MT85005	25	M14	Max 11.000



Cup Wheel for UCS Materials (Dry Cutting) For Portable Machines

<i>ADI Code</i>	<i>Description</i>	<i>RPM</i>	<i>FEED [mm/min]</i>
PE08232	Φ115x30 F=M14		Manual

SUGGESTED RPM 2.000 – 3.000
MAX RPM 3.500

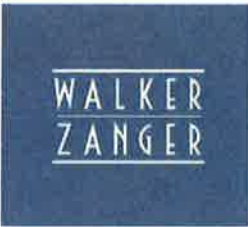

ENHANCER

AGER

Strong wet effect enhancer. Anti-graffiti.

Strong Wet-effect enhancer. Water-oil repellent. Anti-graffiti. For manual application.



Solvent based



Enhancer



Anti-Graffiti

Size 1 lt

⊕ Strong

⊕ UV resistant

⊕ Excellent water-oil repellent properties



POWERBOND

Strong and ultra rapid glue pre-colored.

High Adhesion system for indoor and outdoor bonding and coupling of ceramic. The speed and the adhesion strength in a cartridge available in a wide range of colors.



Zero yellowing



Gel



Indoor/Outdoor

Size 215 ml

⊕ Excellent strength

⊕ Ultra fast

⊕ Zero VOC



EPOXYGRES

Extra strong epoxy glue

Used for the structural bonding of ceramic for a secure and long-lasting hold.



Solid



Indoor/Outdoor

Size 1 lt + 1 lt

⊕ Excellent strength

⊕ Ideal for mixed materials bonding

⊕ Usable on wet surfaces